

DUCATO

AUTOMATIC SLIDING DOOR AND STEP SYSTEMS



CONTENTS

- Main components of door system 3 - 9
- Advantages of door system 9 – 10
- Security systems of door system 10
- Working way of door system10
- Assembling of door system 11 – 25
- Working and control of door system 36 – 29
- Maintenance of door system 30
- Warranty terms of door system 30 – 31
- Fault diagnosis at door system 32

MAIN COMPONENTS OF DOOR SYSTEM

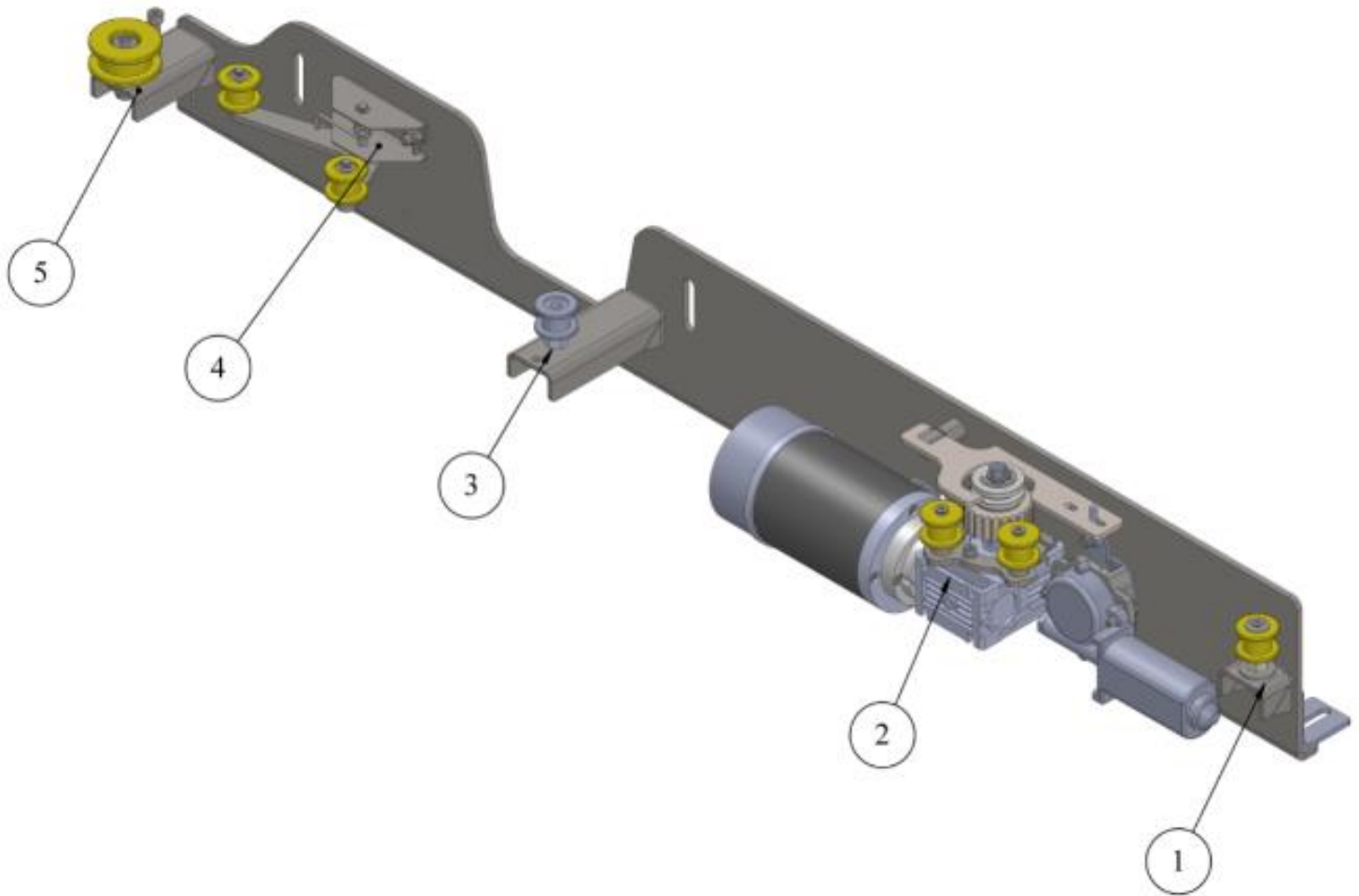

NO.	PART DESCRIPTION
1	FRONT FOOT GROUP
2	MOTOR (ENGINE) GROUP
3	MIDDLE FOOT GROUP
4	BELT TURNBUCKLE GROUP
5	REAR FOOT

MAIN COMPONENTS OF DOOR SYSTEM

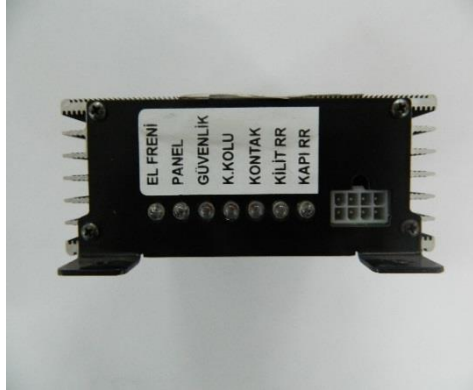

Control Unit



Electrical Wiring: It provide to movement and signal control of automatic door.



In-door electrical wiring: It provides to spent less power of automatic door for bring from the open position to the closed position

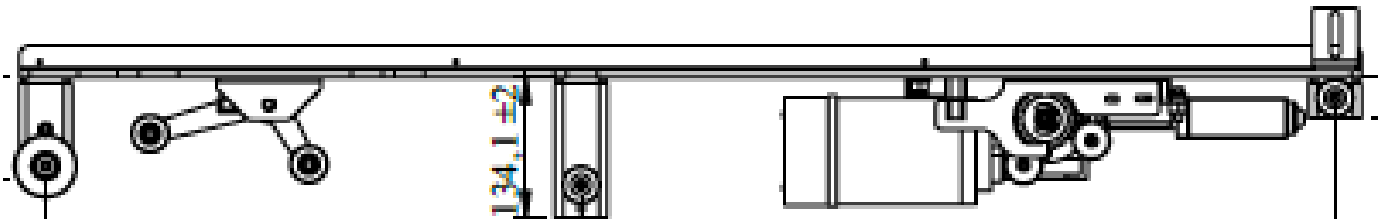

Door drive mechanism: it is the part that contains the system units and is placed under the automatic door on the vehicle chassis.

MAIN COMPONENTS OF DOOR SYSTEM



Unbolting System: It is the mechanism that automatically opens the door without changing the original lock mechanism of the vehicle door.



Motor(Engine) Group

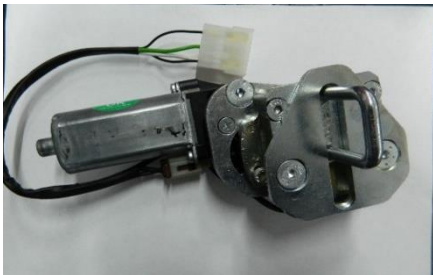

Lock Puller System: The automatic door ensures that less force is exerted to bring it from the open position to the closed position.



Cable Sheaves: Cable sheaves absorb the belt looseness that occurs during sudden changes in direction of the automatic door.

Movement Sheaves: Allows you to complete the motion in a frictionless manner by determining the direction of motion.

MAIN COMPONENTS OF DOOR SYSTEM



Encoder: It allows automatic position information of the door to be transferred to the control unit and distance adjustment can be made.

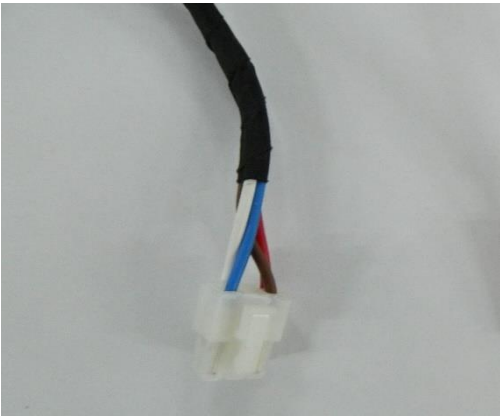

RF receiver cable

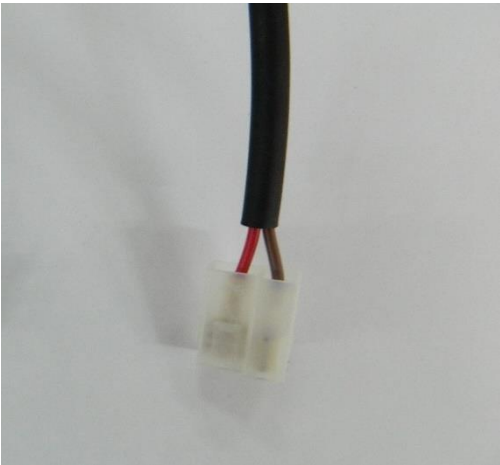

Bottom engine grasp cable

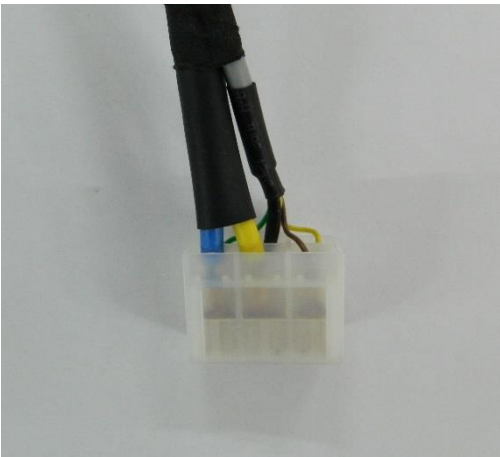

Main system engine socket

MAIN COMPONENTS OF DOOR SYSTEM



(-) ve (+) points of main system wiring

Note: This has to be connected to the vehicle's battery.

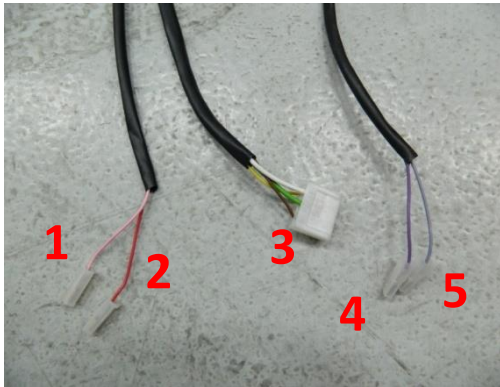

Main wiring cable points

1. km (speed) signal cable
2. Ignition open signal cable
3. Lock pulling cable
4. Middle door remote control signal
5. Reedrelay cable

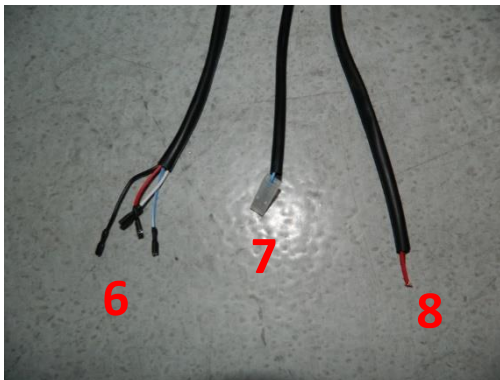

Main wiring cable points

6. Front panel button cable
7. Front door signal cable
8. Wick shoot cable



RF transmitter module

Note: RF transmitter module is installed inside the door

MAIN COMPONENTS OF DOOR SYSTEM

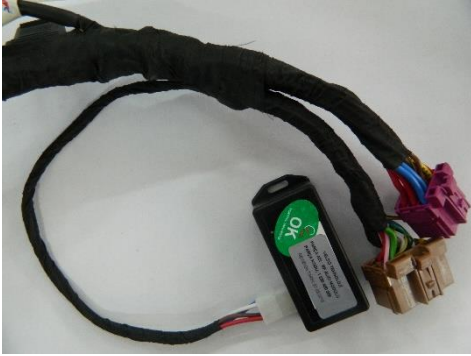

The way the RF receiver module is installed.

Inner door wiring cable points



Unbolting engine cable

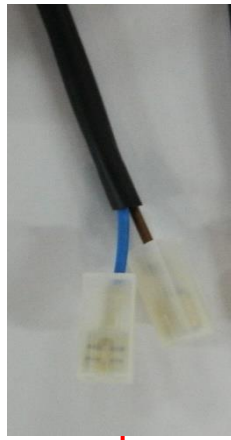

Door handle switch cable

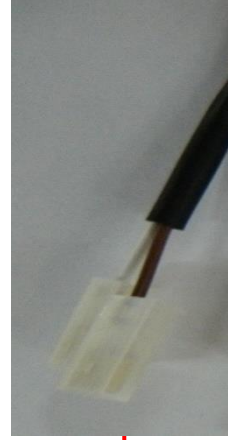

Security wick cable

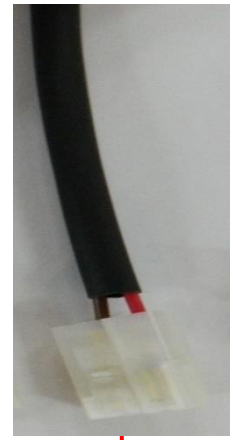

Switch signal and motor lock signal points will be connected here

SECURITY SYSTEMS OF VELDO DOOR



Security wick: The automatic door allows the door to open automatically in case of any obstruction or jamming.

Overcurrent control: It is a security system that is switched on when the security wick is disabled.

User controlled security system: When the door is automatically closed, the door automatically opens when the user commands from the front panel button or the door opening lever.

Audible and light warning system: If the automatic door is opened through the door opening handle while the vehicle is moving or stopping, the user is alerted by voice. There is a short tone audible warning during closing, long tones interrupted and audible warning during opening.

As the door opens and closes, the control unit gives an audible warning.

When the door is open, the user is alerted by the light on the front panel button.

SECURITY SYSTEMS OF VELDO DOOR

Speed-controlled safety system: When the vehicle is moving when the vehicle speed is above a certain limit (5 km / h) and the door is not open and the door is open; it automatically closes when a certain speed limit (5km / h) is exceeded. Also, if the sliding door is attempted to open manually from the inside when the vehicle is moving, the system prevents the door from opening.

In case of accident or emergency: In case of emergency, the vehicle door can be opened manually from the inside and outside from the original door opening levers manually

WORKING WAYS OF VELDO AUTOMATIC DOOR SYSTEM



1 - With the on / off button mounted on the front chest

KAPI
AÇMA-KAPAMA



2 – With original remote control of vehicle

ASSEMBLING OF AUTOMATIC DOOR



Driver and passenger seats are first removed and removed from the car in order to mount Veldo automatic sliding doors.



The batteries under the driver's seat of the vehicle are removed as shown in the figure.



Ø 12 mm punch hole is drilled for take wirings under the vehicle.

ASSEMBLING OF AUTOMATIC DOOR



The wiring is put under the vehicle through the holes drilled. The section on the top of the vehicle is as seen in the figure.



Images of the wiring under the vehicle are like the way.



ASSEMBLING OF AUTOMATIC DOOR



The security wick is installed according to the form of the door.

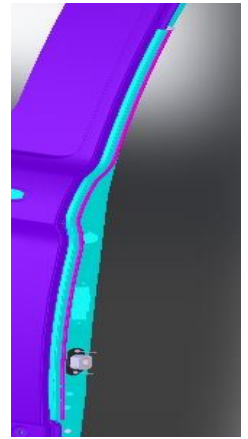

Security wick the cable pass hole is drilled from the spot marked in the figure.

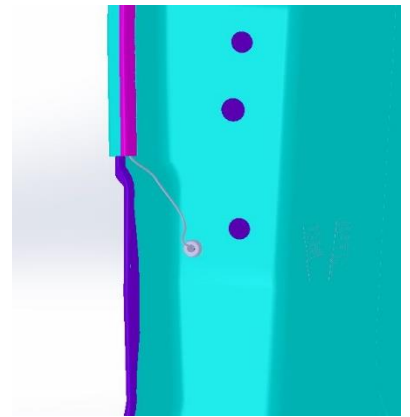

The security wick cable is connected to the inner door installation color to color.



ASSEMBLING OF AUTOMATIC DOOR



Cutting process is done with air saw.



It is then cut from drawn places.



The vehicle's original lock counterpart is dismantled.



Centering is done according to the original equivalent for the lock puller mechanism.

It is marked with the corresponding sheet as shown in the figure.

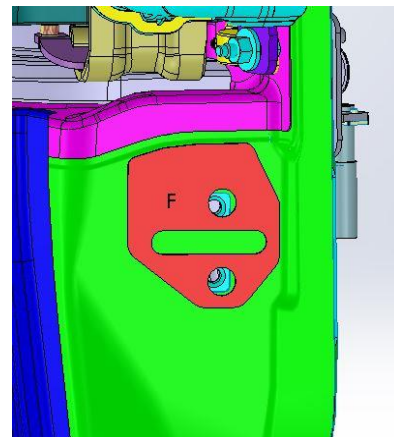

ASSEMBLING OF AUTOMATIC DOOR

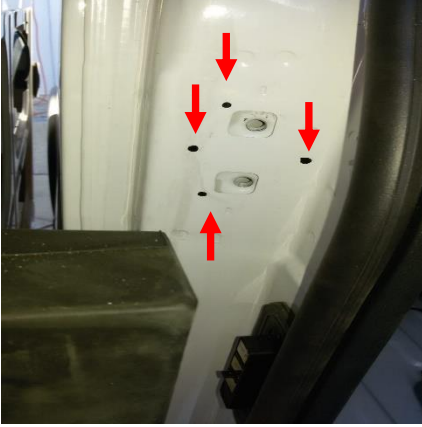

It is drilled from corners with \varnothing 10 mm drill.



The cut is done as in the figure.



The cut is done as in the figure.

The lock puller mechanism is installed as shown in the picture. (from outside)

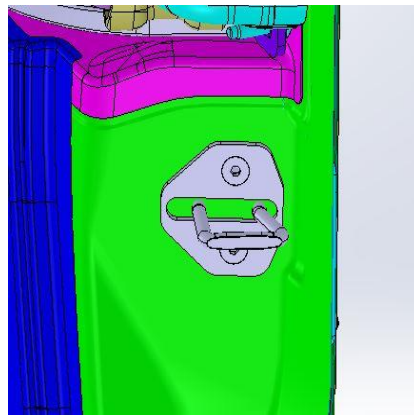

ASSEMBLING OF AUTOMATIC DOOR

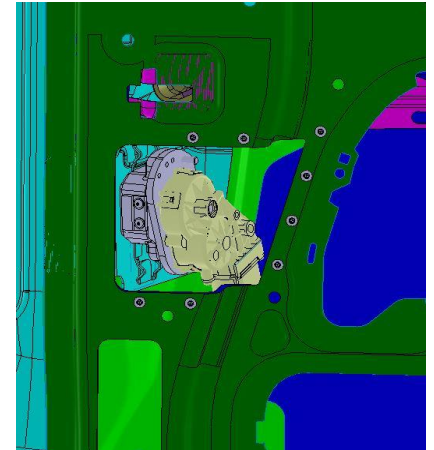

The lock puller mechanism is installed as shown in the picture. (from inside)



The front mast connection is connected according to the diagram.



The door on/off button cable plugs in the main system installation are attached to the button. The panel is then assembled into place.

- = White,
- + = Red,
- COM = White-blue
- ON = Black

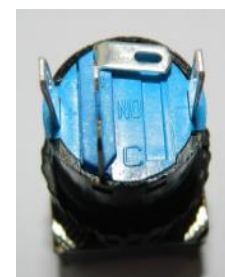

ASSEMBLING OF AUTOMATIC DOOR



40 mm and 60 mm marks are made for the rear foot connection by reference to the region seen in the figure.



Ø 30 mm punch hole is drilled from the marked area.



Rear foot assembly is done.



ASSEMBLING OF AUTOMATIC DOOR



The parts seen in the figure are cut with the help of an air saw.



The cut section is as seen in the figure.



The parts seen in the figure are cut with the help of an air saw.



The cut section is as seen in the figure.

ASSEMBLING OF AUTOMATIC DOOR



The area shown in the figure is cut for the main chassis assembly.



The cut section is as seen in the figure.

ASSEMBLING OF AUTOMATIC DOOR



The original foot of the vehicle is removed for the belt connection process.



The belt mounting bracket is connected to the original foot of the vehicle as shown in the figure.



ASSEMBLING OF AUTOMATIC DOOR



The belt crossing route is as in the figure.

ASSEMBLING OF AUTOMATIC DOOR



The locking mechanism is as shown in the figure.



ASSEMBLING OF AUTOMATIC DOOR

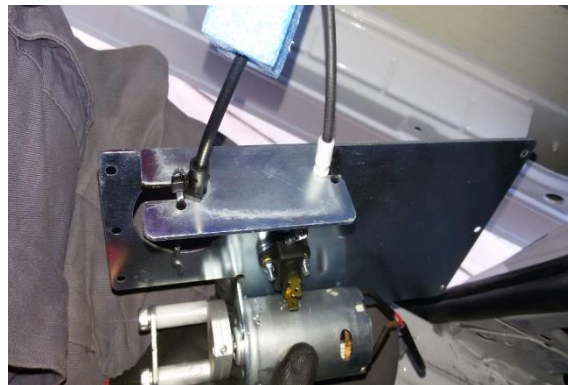

The wire removed from the rear lock is assembled as seen in the figure.



ASSEMBLING OF AUTOMATIC DOOR



The assembly process of the locking mechanism to the vehicle's cover is as follows.



ASSEMBLING OF AUTOMATIC DOOR



The door switch is installed in the area seen in the figure.



The installation process is performed under 2 mm of the original insulation material on the B pillar of the vehicle



The red cable for the ignition signal connects to the blue white cable in the vehicle installation.

The pink cable for the speed information signal connects to the vehicle's km/h information cable.

WORKING AND CONTROL OF AUTOMATIC DOOR SYSTEM

Initial working status: Control unit is connect to facilities and when the insurance is installed and the first energy is supplied;

-The remote control of the car is activated by pressing the central locking buttons, then the central locking button is activated and the remote control is activated.

- The door is manually opened. When the panel button is held pressed and the short buzzer starts to be heard, the open command from the control panel is given and the panel button is released. In this case, the door first goes to the closing direction, then to the opening direction and finally the door closes completely, The buzzer 2 identifies the encoder by giving a short beep.

- In this position, the buzzer is constantly bouncing and waiting for commands. Door closes after command. All the lights on the control unit are turned off and the buzzer is muted.

General Work:

When the door is opened

- The lock catcher gives out the door.
- Unlocking engine unlocks the door by tapping the unlocking wire.
- The door starts to open the engine door, during this operation the buzzer will be tugged in long tones to indicate that the door has been opened.
- Opening is as much as the taught opening, the door system measures this distance with the encoder

WORKING AND CONTROL OF AUTOMATIC DOOR SYSTEM

General Working:

When the door is closed

- The door starts closing the engine door, during which time the buzzer alerts you that the door is closing in short tones.
- When the door is completely the buzzer finishes the hoisting operation,
- The lock pull mechanism pulls the door in.

Door operation settings: The part where the control settings of the control unit are made. These settings are made when the ignition is switched off. These settings are;

1- Door distance adjustment :

- The door opens manually to the desired distance, the buzzer is uninterrupted and continuously bounces.
- Press and hold the panel button, is entered into the learning mode (the situation where the buzzer is intermittently interrupted) without leaving the panel knob.
- The door learns the encoder direction by first going to the closing direction and then to the opening direction.
- After this process, the door goes back to the closing direction and closes the door completely.
- The locking catch pulls the door, the buzzer shuts the long probe twice, so the door distance is taught.

WORKING AND CONTROL OF AUTOMATIC DOOR SYSTEM

Door operation settings: It is the part where the operation settings of the control unit are made. These settings are made when the ignition is switched off. These settings are;

2- Doorhandle Activation:

- Press and hold the panel button to enter the learning mode.
- The panel button will be depressed as long as the buzzer is cut off - it will not be left until it is cut.
- After a while the buzzer is shut up
- Once the long end has been activated, the outer door handle becomes activated
- If the shorter probe bites twice, the outer door arm becomes passive.

Security:

1- When the door is opened:

- If there is an obstacle in the opening direction, the door stops with overcurrent.
- During the opening process, it is expected that the door will be closed again with the panel button or the control.

2- In case of emergency:

- If the vehicle speed is below 20km and the central locks are closed then if the vehicle speed falls below 5km and the ignition is open, the door lock is opened if the outer door is pulled, The door can be opened manually with the internal emergency arm.) In this case, the buzzer is constantly bouncing.

* These features are optional.

WORKING AND CONTROL OF AUTOMATIC DOOR SYSTEM

3- When the door is closed: If one of the following events occurs, the door stops and reopens.

- If a jamming door in the closing direction detects excessive current,
- If there is a impact in the safety wick while the door is closed
- If the door is pulled out while the door is closed
- If the panel button is pressed while the door is closed
- If the control is pressed while the door is closed

On-off commands:

1- Close commands:

- If the vehicle is moving and the vehicle speed is 5 km or more and the door is attempted to be opened from the inside, it closes immediately without allowing manual opening.
- If the door is opened automatically, if the vehicle is started and the handbrake is lowered, the door goes to the close and even if the open commands are given in this position, the door is not opened, it is notified in short tones by voice warning.
- The door is open and the car speed is 5 km and automatically switches off regardless of how it is opened or in which position it is.
- When the door is open and the vehicle speed is less than 5 km, the parking brake is activated when the handbrake is applied or the ignition is off. The door automatically closes when the control is active.

2- Open commands

When the door is closed and the vehicle speed is below 5 km, the handbrake is applied or the ignition is switched off automatically when the panel switch and the control are active.

ATTENDANCE OF DOOR SYSTEM

- Automatic Automatic door and step systems must be maintained once a year.
- System General Checks are done.
- The system belt changes.
- The unlocking pattern changes.

NOTE: Uncared products will be evaluated outside the scope of the Guarantee.

TERMS OF GUARANTEE OF DOOR SYSTEM

The terms of the warranty are part of the purchase agreement between the Veldo authorized dealer and the customer. The customer accepts the warranty terms by signature. Veldo guarantee certificate is given to the customer during delivery of the vehicle. The customer is required to present this document in order to be able to process the warranty. All of the automatic door / step including the parts are guaranteed for 2 years. The start of the guarantee is the delivery date of the Product Assembly or Customer.

DISCLAIMER OF WARRANTY TERMS

- Maintenance and repair of the automatic door / step must be carried out on time, regularly, by the appropriate technical knowledge and competent services and in accordance with the periodic maintenance and repair procedures.
- Failure to follow the instructions in the user manual.
- Automatic door / step; is used under improper conditions or under overload except for the purpose,
- If an original or non-equivalent part is attached to the automatic door / step, or if a change has been made by the manufacturer which is not technically approved,
- If the need for repairs in the purchased item is not reported in time,
- In spite of the warning made by the service, if the vehicle owner or the user has not provided the opportunity to repair it
- Defects due to use at high temperatures from extremely dusty, damp, (+ 80), (- 30) degrees
- Failures caused by natural disasters such as flood, fire, earthquake etc.
- The depreciation and abrasion of the parts which are the result of normal use and the nature of the material is not guaranteed. Examples of these pieces that have been subjected to abrasion include system belt, unlocking tines and rollers. However, parts are guaranteed if the material, workmanship and assembly error, that is, the fabrication error, are detected in these parts. If there are any changes or modifications to the product, the warranty does not apply in case of malfunctions.
- Faults caused by insect or animal damage to the product or damage to the product cables.

FAULT DIAGNOSIS AT DOOR SYSTEM

Fault	Cause	Control Points
The door never moves.	<ul style="list-style-type: none"> • The fuse might have been thrown out. • The system belt may be broken. • The unlocking motor may be faulty. • Unlocking cable may be broken. 	<ul style="list-style-type: none"> • Fuse defects should be detected and corrected • The system belt is checked, if it is broken, it is changed. • If the unlocking turns idle and the sound of buzzing sounds, the wire is broken and replaced with the new one. • If the door is operated from the control, the button is defective and the change is made.
The door is opened, the engine is running but the door is not opened.	<ul style="list-style-type: none"> • Unlocking cable may be broken. 	<ul style="list-style-type: none"> • If the unlocking motor is idling and sounding buzzing, the wire is broken and replaced with the new one.
After the door is opened, it is jerking off.	<ul style="list-style-type: none"> • The belt turnbuckle group may be defective. 	<ul style="list-style-type: none"> • The belt turnbuckling spring may be broken, a spring change is made.
The door is moving intermittently when opening / closing.	<ul style="list-style-type: none"> • The reedrelay may be faulty. • The encoder may be faulty. 	<ul style="list-style-type: none"> • A magnet is held in front of the reed relay, and if the lock pulling motor is not working, the reed roll is faulty. • The magnet is held in front of the reed relay, the encoder is defective if the lock pull motor is running.
After the sliding door is commanded, it is going to open continuously.	<ul style="list-style-type: none"> • The reedrelay may be faulty. 	<ul style="list-style-type: none"> • A magnet is held in front of the reed relay, and if the run does not run, the reed relay is faulty.
When the door closes, the buzzing sound comes.	<ul style="list-style-type: none"> • lock puller may be faulty. 	<ul style="list-style-type: none"> • After the door closes, the lock catch is checked. Since there may be a problem in the gear, the lock pulling mechanism is changed.
After the door closes, it stays outside, behind the door remains a gap.	<ul style="list-style-type: none"> • lock puller may be faulty. 	<ul style="list-style-type: none"> • If the magnet is held in front of the reed relay, there is no movement with the lock puller, or if the U is broken.
Security wired does not work	<ul style="list-style-type: none"> • Door control unit may be faulty. If the checks we've done are not working on the final wicket, If the door is not stalled when you trigger the white wire (-) in the main system installation, the control unit is faulty. • There may be a problem with the safety wired electrical installation. 	<ul style="list-style-type: none"> • Open the door. when the brown cable is connected with the white cable, if the door stops and goes back, the wick is defective. Change roving. • If the door stops and does not go back, when I give the white cable (-) trigger to the under the door (OPKON cable) under the front right seat, if the door stops and goes back, there is a break in the OPKON cable under the door. Change the opkon cable. • If the fuse still does not work, the control unit is faulty if the door does not stop and return when you trigger the white wire (-) in the main system installation.