

TRANSIT



VELDO AUTOMATIC SLIDING DOOR SYSTEMS



CONTENTS

- Main parts of door system 3 - 10
- Benefits of door system 9 – 10
- Security systems of door system 11 – 12
- Working type of door system12
- Assembling of door system 13 – 32
- Working and control of door system 33 – 36
- Maintenance of door system 37
- Warranty terms of door system 37 – 38
- Fault diagnosis of door system 39

MAIN PARTS OF DOOR SYSTEM

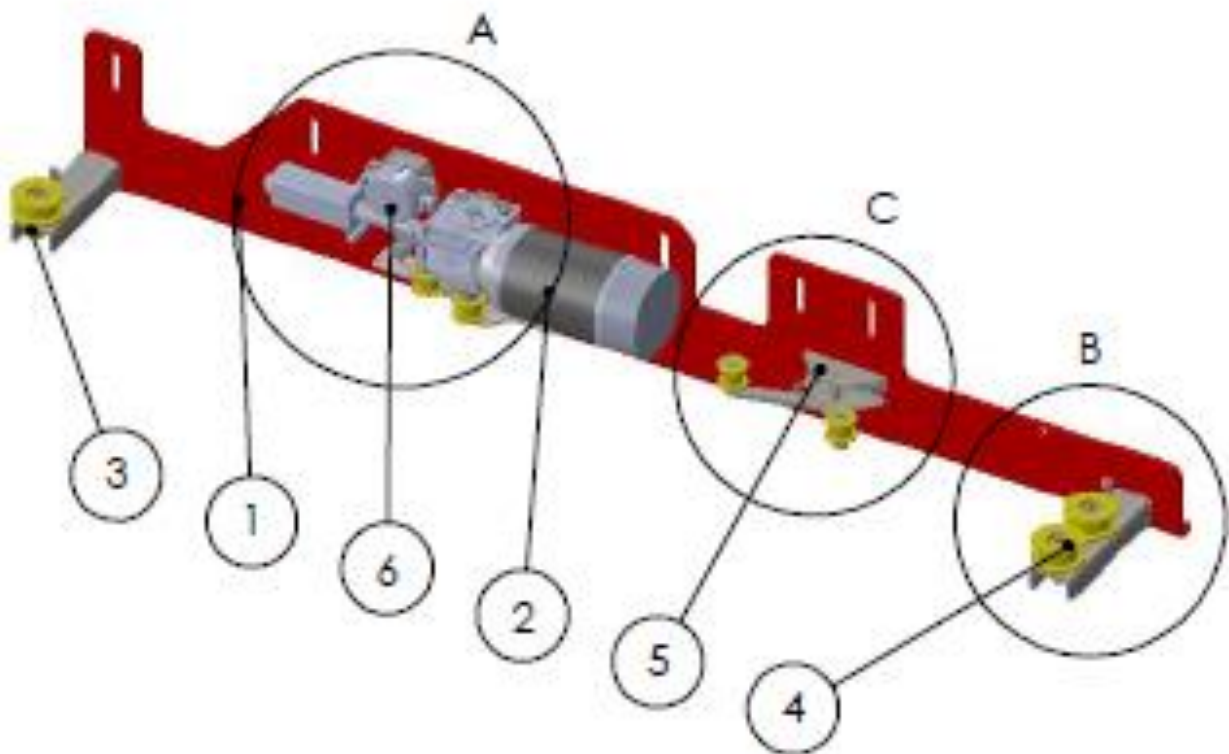

ITEM NO.	DESCRIPTION OF PART
1	FORD CHASSIS
2	MOTOR GROUP
3	LONG FOOT GROUP
4	LONG FOOT GROUP FORD 185 mm
5	BELT TURNBUCKLE STATUS
6	LOCK PULLER GRASP GROUP

MAIN PARTS OF DOOR SYSTEM

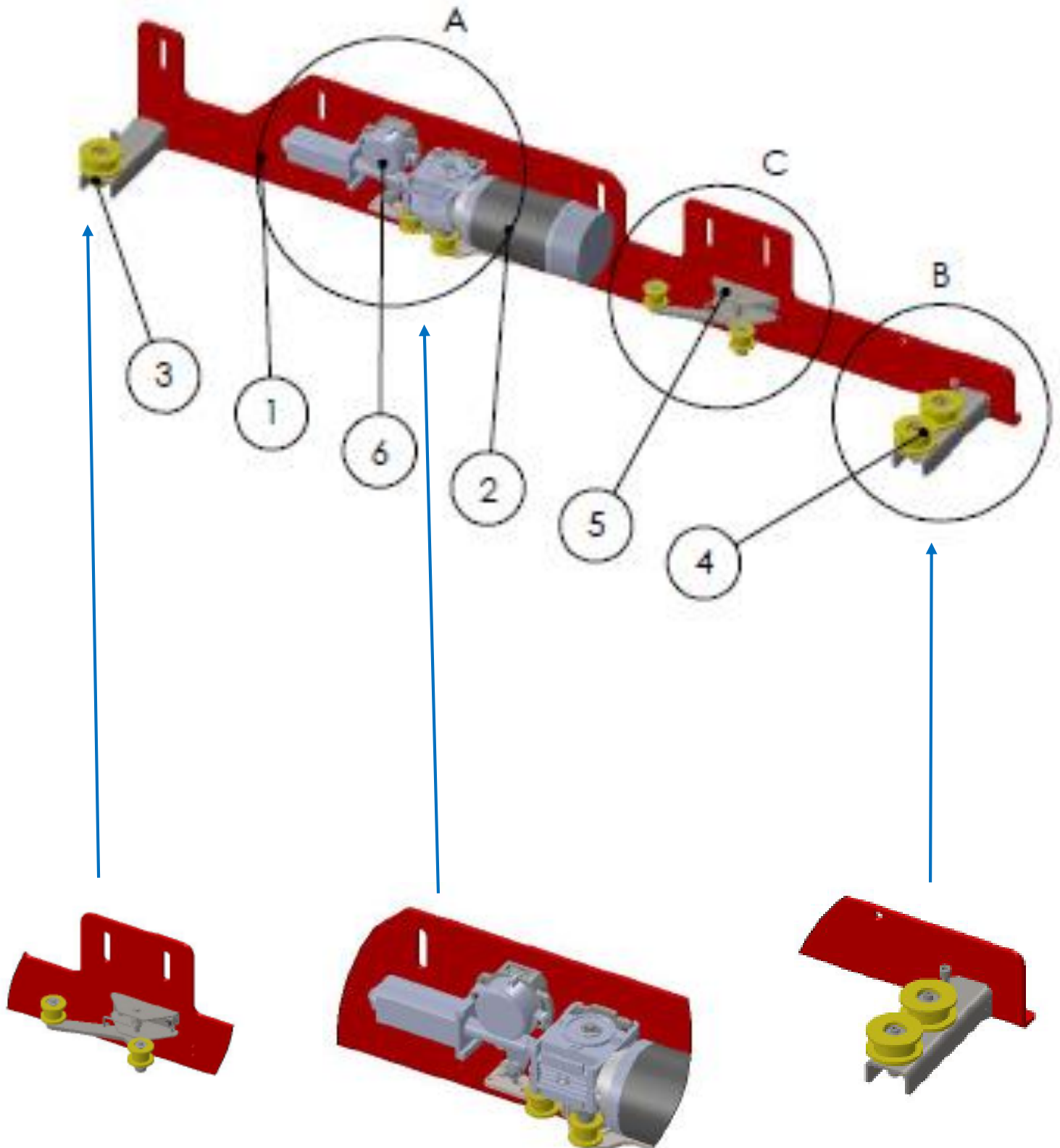

Clutch Centre Control Unit

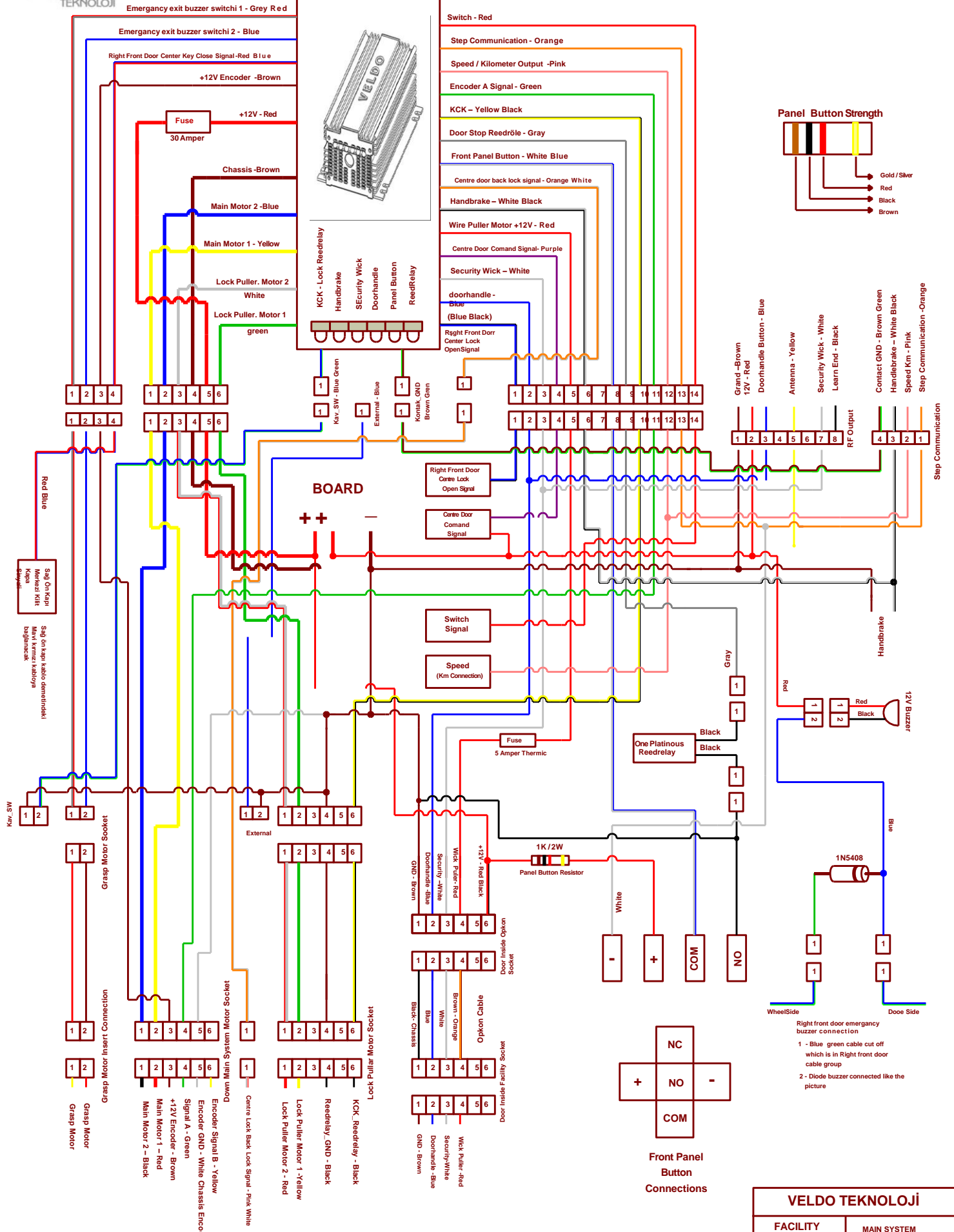

Clutch New Door System Installation

VELDO SSH

VELDO TEKNOLOJİ	
FACILITY NAME	MAIN SYSTEM FACILITY
REVISION	SKK260E - V15
WRITTEN BY	MEHMET DURAN 5

MAIN PARTS OF DOOR SYSTEM

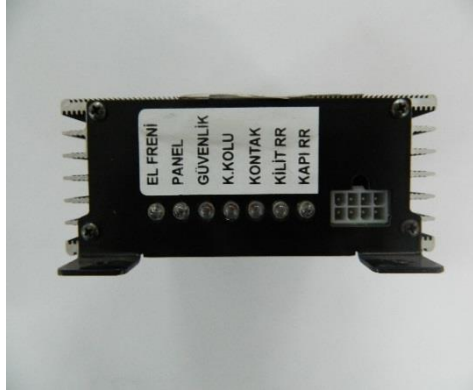

Control Unit



Electrical Wiring : It provide to movement and signal control of automatic door.



In-door electrical wiring: It provides to spent less power of automatic door for bring from the open position to the closed position.

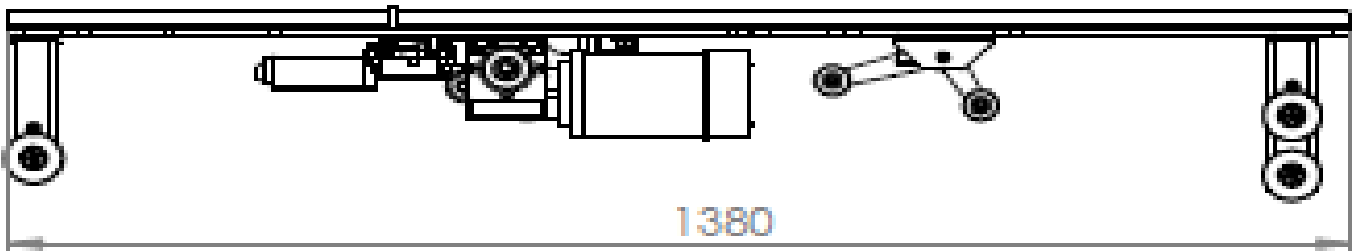

Door Excitation Mechanism: It is the part of the system containing the units and placed under the automatic door on the vehicle chassis.

MAIN PARTS OF DOOR SYSTEM



Unbolting System: It is the mechanism that automatically opens the door without changing the original lock mechanism of the vehicle door.



Motor Group

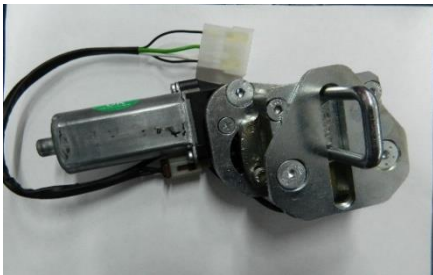

Lock Puller System: The automatic door ensures that less force is exerted to bring it from the open position to the closed position.



Cable Sheaves: Cable sheaves absorb the belt looseness that occurs during sudden changes in direction of the automatic door.

Movement Sheaves: Allows you to complete the motion in a frictionless manner by determining the direction of motion.



Reed relay: It transfers the information that the automatic door is open or closed to the control unit.

MAIN PARTS OF DOOR SYSTEM



Encoder: It allows automatic position information of the door to be transferred to the control unit and distance adjustment can be made.

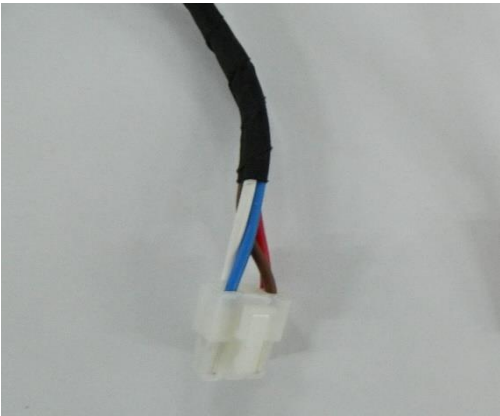

RF receiver cable.

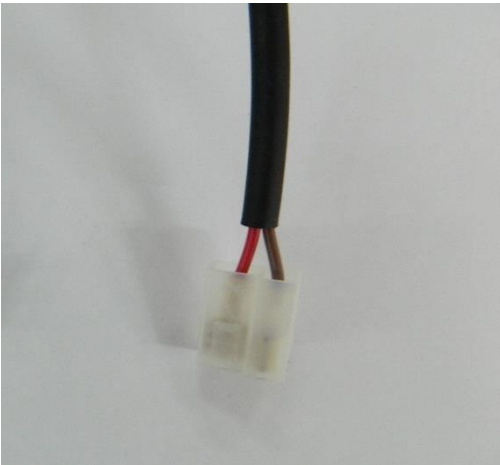

Motor bottom grasp cable.

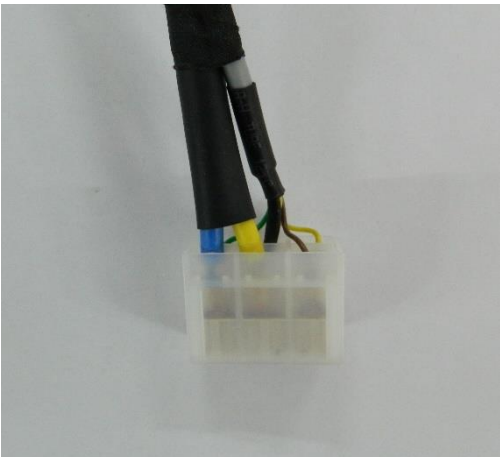

Main system motor socket

MAIN PARTS OF DOOR SYSTEM



(-) ve (+) points of main system facilities

Note: It have to connect to vehicle accumulator.

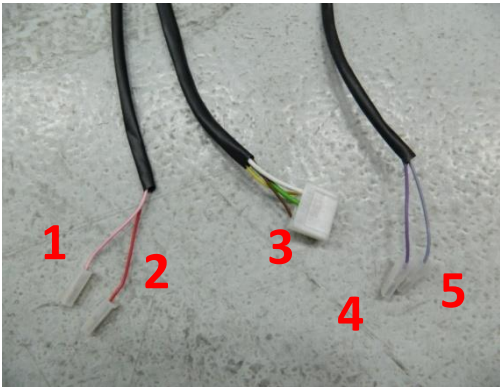

Main facilities cable points

1. Km signal cable.
2. Contact open signal cable.
3. Lock puller cable.
4. Centre door command signal.
5. Reedrelay cable.

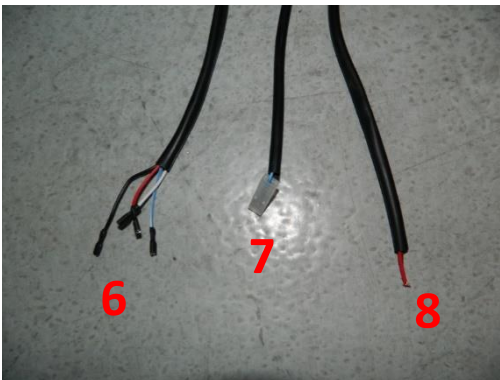

Main facilities cable points

6. Front panel button cable.
7. Front door signal cable.
8. Wire bump start cable.



RF feeder module

Note: The RF transmitter module is plugged into the door

MAIN PARTS OF DOOR SYSTEM

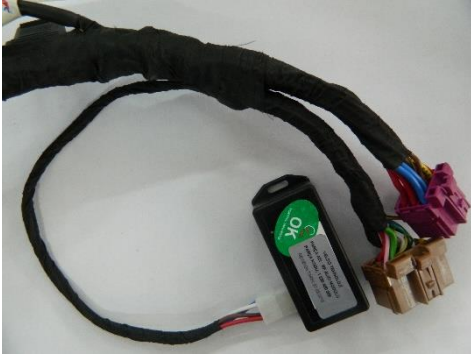

The shame of the RF reeder assembling.

In-door installation cable points



Unbolting motor cable

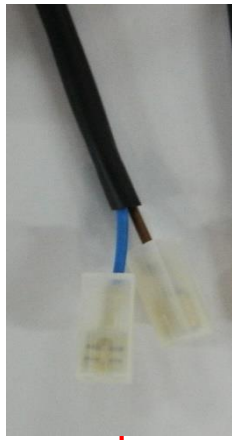

Door handle switch cable

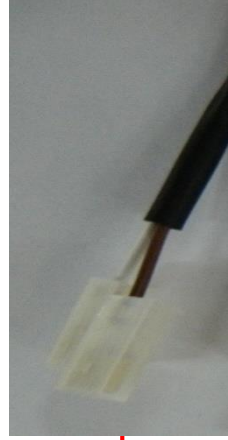

Security wick cable

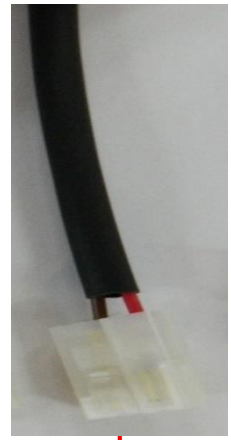

Switch signal and motor lock signal points connect here

SECURITY SYSTEMS OF VELDO AUTOMATIC DOOR



Security Wick: Allows manual opening of the door from the outside in emergency situations.

Over current control: It is the security system that is activated if the safety fuse is excluded.

User controlled security system: When the door is automatically closed, the door automatically opens when the user commands from the front panel button or the door opening lever.

Audible and light warning system: If the automatic door opens when the vehicle is moving or standing, if the door is opened from the inside opening arm; the user is audibly alerted.

In the form of an audible warning in short tones during closing, there is an intermittent audible warning in long tones during opening. When the door is opened and closed, the control unit sounds an audible warning. The user is warned by the light in the front panel button when the door is open.

SECURITY SYSTEMS OF VELDO AUTOMATIC DOOR

Speed-controlled safety system: When the vehicle is moving when the vehicle speed is above a certain limit (5 km / h) and the door is not open and the door is open; it automatically closes when a certain speed limit (5km / h) is exceeded. Also, if the sliding door is attempted to open manually from the inside when the vehicle is moving, the system prevents the door from opening.

In case of accident or emergency: In an emergency, the car door can be opened manually from the original door opening handles inside and outside.

WORKING WAYS OF VELDO AUTOMATIC DOOR SYSTEM



1 - With the on / off button mounted on the front chest,

KAPI
AÇMA-KAPAMA



2 - With the original command of the vehicle.

ASSEMBLING OF AUTOMATIC DOOR



Driver and passenger seats are first removed and removed from the car in order to mount Veldo automatic sliding doors.



Batteries are removed which located under the driver seat as shown.

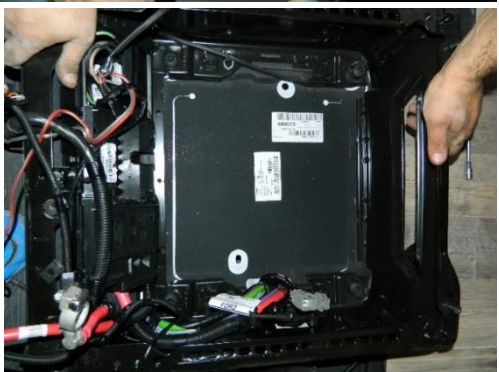

ASSEMBLING OF AUTOMATIC DOOR

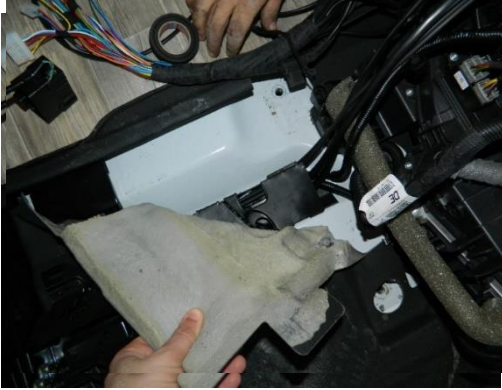

After the cable duct covers are removed, the front part of the vehicle is brought to a lowered position.

Note: Through this channel, (+), (-), (km cable), (contact electricity) of automatic door installation are passed.

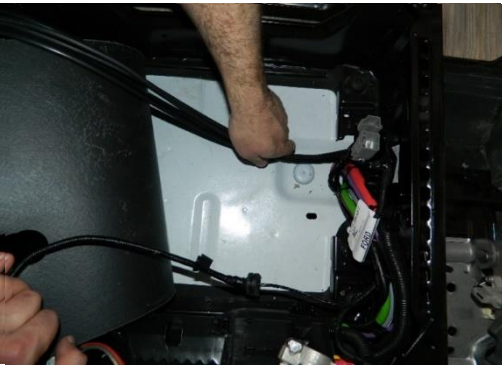

B mast overlay is removed after removing the inner handle and hanger pin on the B mast.



ASSEMBLING OF AUTOMATIC DOOR



The coating on the inner step coating and the inner step are removed.

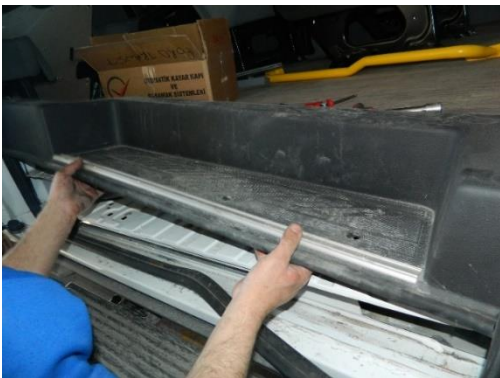

The drawn part is cut as if it is in picture.



The top and bottom coverings of the sliding door are removed. Back cover, C direct cover and Wick are removed.

ASSEMBLING OF AUTOMATIC DOOR

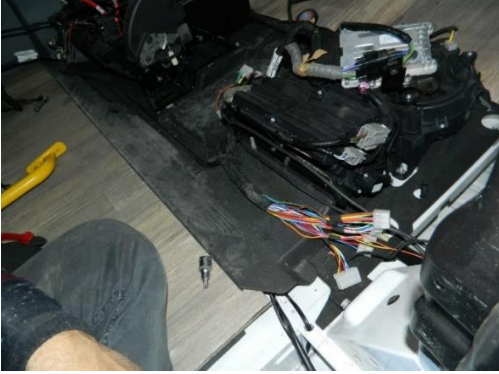

The door control unit should be placed so that the passenger seat is not damaged.



Note: The main engine installation cable runs through the plumbing under the passenger seat.



The front door control signal cable in the main system installation is connected in blue black and as shown.

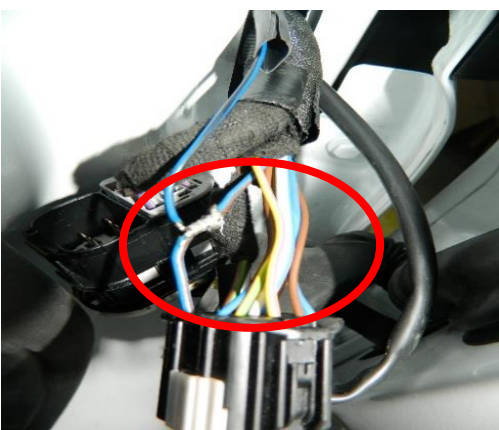

Note: It is recommended to use solder when doing this operation.

ASSEMBLING OF AUTOMATIC DOOR



As shown, the signal is connected to the routing switch scheme.



Note: when the original Switch connection is made, it must first be made in-door connection.

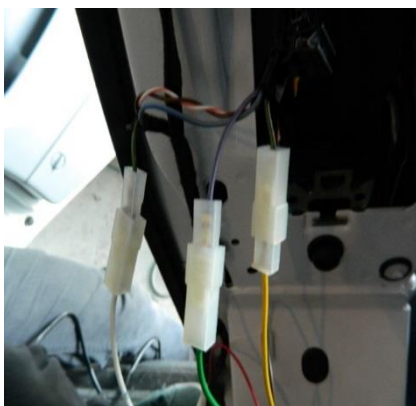

Original Switch Connection Schema of Ford Transit and Custom

Switch Control Unit Connection of mainmast

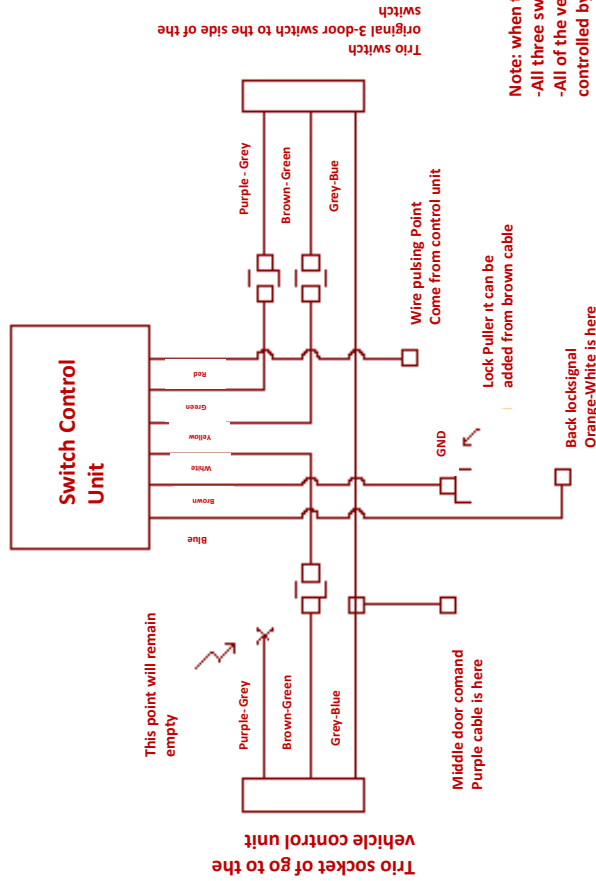

Blue-Black cable connection



Signal Routing Connection of Inside the door

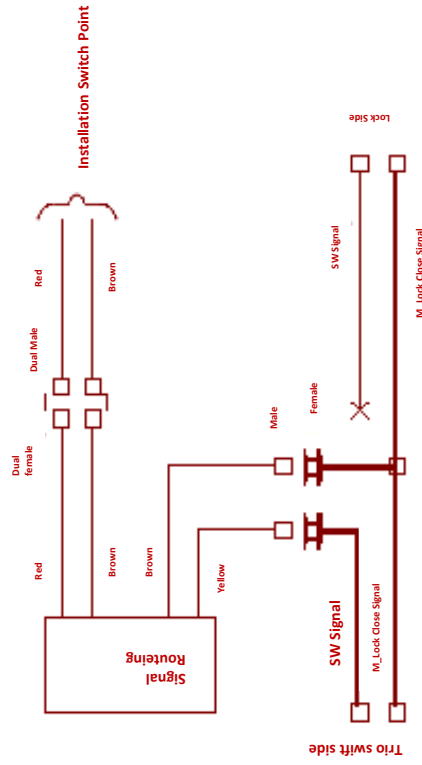

Note: when the original switch connection is made, first the in-door connection will be made i

- All three switch cables inside the door are black, test with control lamp to find the appropriate cable.
- All of the vehicle doors are closed, the control lamp's tongs are connected to GND (chassis), and the cables are controlled by commanding the car from turn-on to turn.
- It is the cable 'M_lock close' which gives a signal to the lock button which performs the closing process of all the doors, where it is linked to the routing module by taking an attachment as in the above schematic.
- The 'SW signal' cable, which does not signal in all commands issued from the control, is cut as if it were on the screen, the part of the cable that is disconnected is left empty, the connection to the switch is made as if the female plug is plugged in on the schematic.

The blue black cable will be connected to the 'blue-brown' cable connected to terminal 17 of the socket on the right front door wiring harness, as shown in the illustration at the side.

The ignition connections should be taken from the small connectors on the side of the accumulator below the driver's seat

ASSEMBLING OF AUTOMATIC DOOR

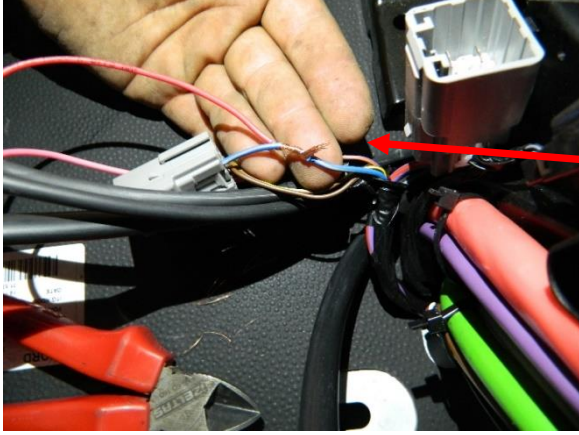

It looks like the km connection and the ignition switch connection is like this.

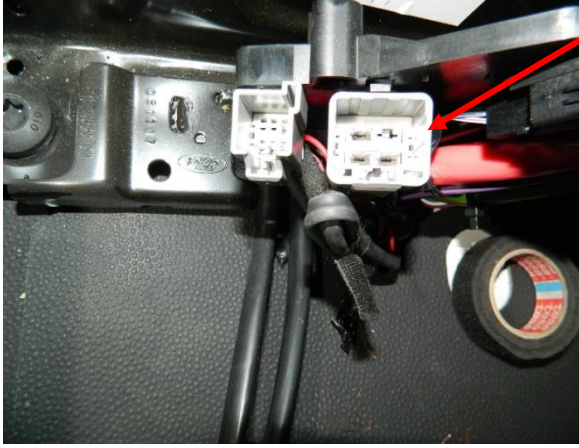
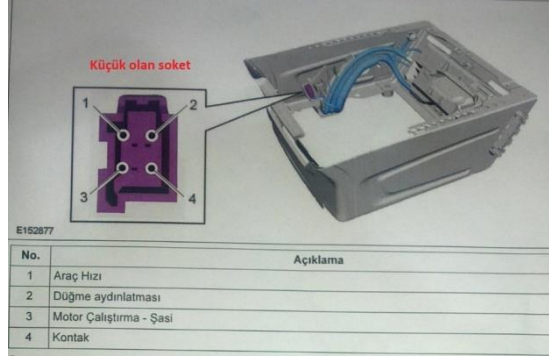

The kilometer signal cable (pink cable) on the main system installation is connected to the small socket as shown below, under the driver's seat.

Note: 1 is the km signal and 4 is the pin contact.

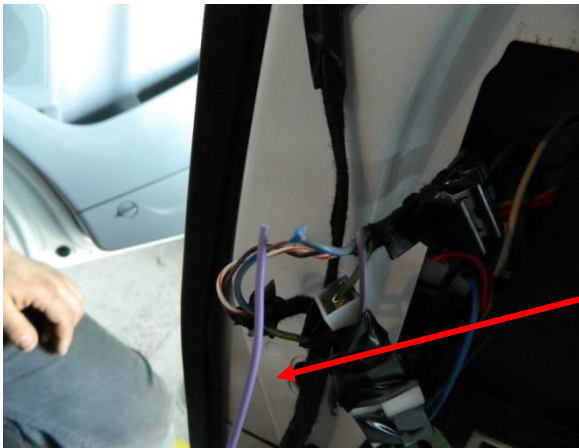

The blue cable above Gray on the installation of the vehicle located on the pole B is taken in addition and connected to the purple cable.

Note: The purple cable is the middle door control signal.

ASSEMBLING OF AUTOMATIC DOOR

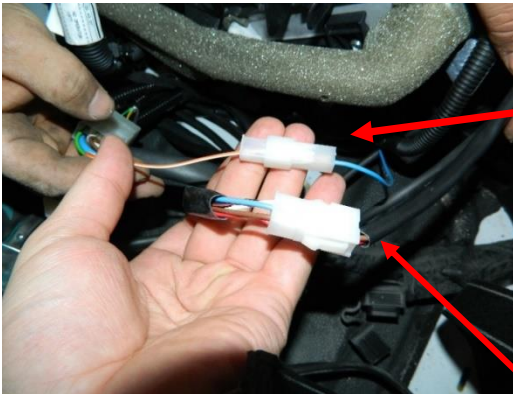

It is the signal convector back lock signal. It is connected to the blue of the module by adding the white on the orange.



The 3-way switch shown in the figure is an additional installation, connected to the brown and red wires of the module .



In the main system installation, the door on / off button cable is brought from the back of the center console to the panel socket and the plugs are attached to the button. Then the panel is installed in place.



- = White,
+ = Red,
COM = White-blue
ON = Black



Panel Button

ASSEMBLING OF AUTOMATIC DOOR



Cutting operation is performed by marking the position of the front guide roller with the roller as seen in the figure.



As shown in the figure, the front roller is assembled.



ASSEMBLING OF AUTOMATIC DOOR



As seen in the figure, the rivets are broken with the help of a drill and the L part is disassembled.



Note: It will not be plugged back.

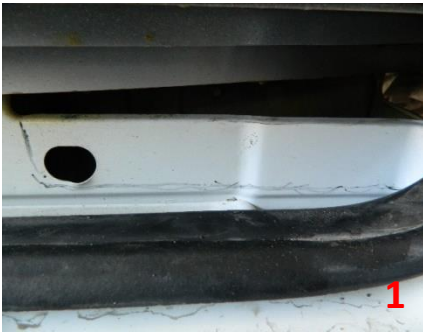

As shown in the figure, after the belt passes are cut off, they are painted with zinc spray.

Note: The area indicated by the red arrow is cut off.

ASSEMBLING OF AUTOMATIC DOOR



Figures 1 and 2 show the places where reference should be taken.

Note: Rear belt guide roller.

ASSEMBLING OF AUTOMATIC DOOR



The smart screw from the end point will be thrown.

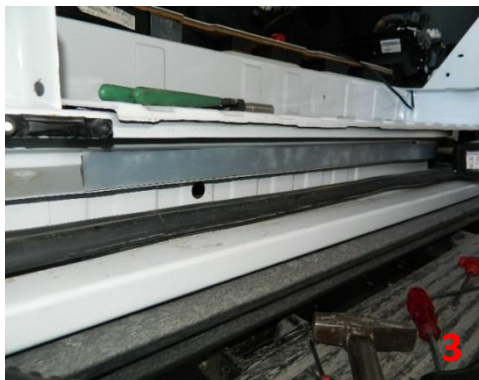

The strap is double-sided tape pulled on one side for mounting the Umpoloni. Mounted as shown.

ASSEMBLING OF AUTOMATIC DOOR



Can be used as a reference

The main system is mounted as shown in the figure.

ASSEMBLING OF AUTOMATIC DOOR



The strap clamping bracket looks like it is attached to the original leg of the vehicle.

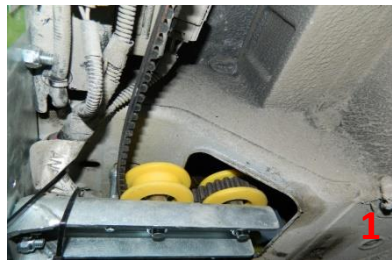

The belt transition points are like this.



ASSEMBLING OF AUTOMATIC DOOR



The belt tension must be adjusted on the slide with maximum strain.



The belt connection bracket will be connected as shown.

ASSEMBLING OF AUTOMATIC DOOR



As shown to place the catching mechanism, the C-arm is marked and cut to fit the installation.



Refer to the original lock on the vehicle as shown and then remove it.



After this process, automatic door lock retraction system is installed.



The cut-out outer sheet is used as a template and the place to be cut is determined.

ASSEMBLING OF AUTOMATIC DOOR



As shown, the original rear lock on the vehicle is removed. The original wire is removed from its place.



The wire slot is extended with a 4.2 mm drill bit. Veldo look out plug, snap in place.



Note: After this operation, the door lock is replaced.

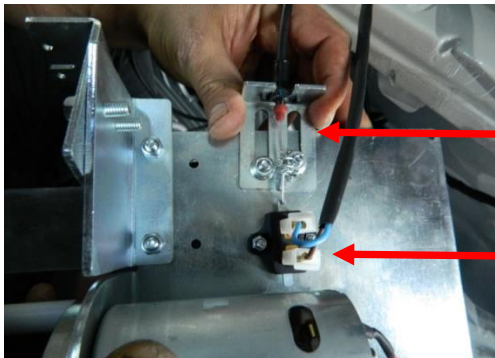

The wire that is pulled from the bottom bracket is attached to the outer door handle switch.

Like the blue and brown cables in the doorway, the door is fitted to the switch in the door.

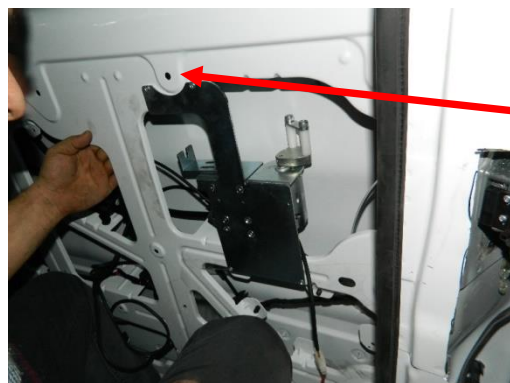

For the unlocking mechanism, mounting is done with reference as seen.

ASSEMBLING OF AUTOMATIC DOOR



The wire removed from the rear lock is assembled as seen in the figure



ASSEMBLING OF AUTOMATIC DOOR

Signal Routing Link Inside the Door

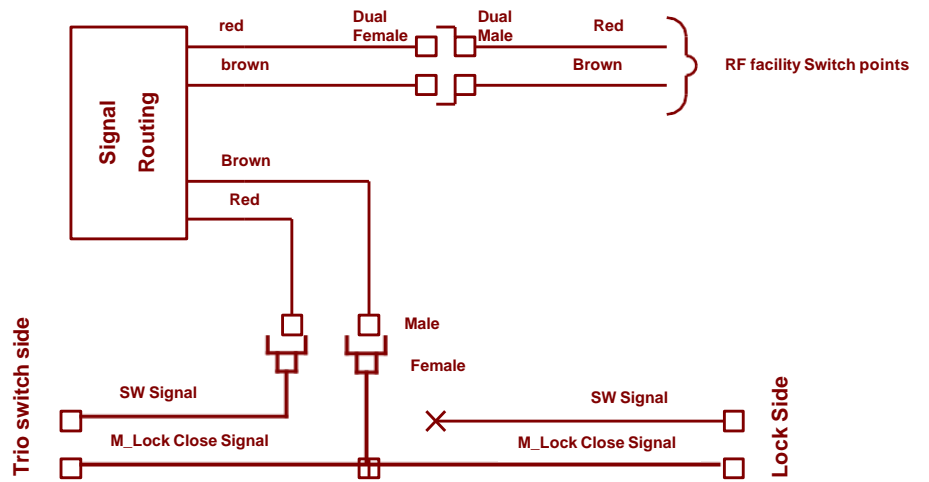

- 3 of the switch cables in the door are black, tested with the control lamp to find the appropriate cable,
- All of the vehicle doors are closed, the control lamp's tongs are connected to GND (chassis), the cables are checked by commanding the car from on to off,
- The signaling cable is "M_Unlock Close" when the lock button which performs all the door closing operations is pressed. from which an additional connection is made to the routing module as in the above schema,
- The cable that does not signal in all commands issued from the control is the "SW signal" cable. this cable is cut as if it is on the screen, the part of the cable that is cut off is left empty, the female part is connected to the part going to the switch,

ASSEMBLING OF AUTOMATIC DOOR



Magnet

First, a magnet is attached, and a marker is placed on the inner upper side with reference to this magnet.



Reedrelay assembly sign.



As it is marked at the sign, the mounting of the reedrelay is done at the right upper corner.

WORKING AND CONTROL OF AUTOMATIC DOOR SYSTEM

Initial working status: Control unit is connect to facilities and when the insurance is installed and the first energy is supplied;

- The central locks of the control are switched to the locked position by pressing the button, then press the central locks open button to switch the control on, so that the command to open the middle door of the controller is activated.
- The door is manually opened. When the panel button is held pressed and the short buzzer starts to be heard, the open command from the control panel is given and the panel button is released. In this case, the door first goes to the closing direction, then to the opening direction and finally the door closes completely, The buzzer 2 identifies the encoder by giving a short beep.
- In this position, the buzzer is constantly bouncing and waiting for commands. Door closes after command. All the lights on the control unit are turned off and the buzzer is muted.

General Working:

When the door is opened

- The lock catcher gives out the door.
- Unlocking engine unlocks the door by tapping the unlocking wire.
- The door starts to open the door of the motor, during which the buzzer is tilted in long tones and the door is opened.
- Opening is as much as the taught opening, the door system measures this distance with the encoder

WORKING AND CONTROL OF AUTOMATIC DOOR SYSTEM

General Working:

When the door is closed

- The door starts to close the engine door, while the buzzer bites in short tones the door is closing.
- When the door is completely closed (if the door reed relay is not defective, it understands this operation with reed relay, if the reed relay is faulty, it understands this operation with over current) the buzzer finishes the hoisting operation,
- The lock pull mechanism pulls the door in.

Door operation settings: The part where the control settings of the control unit are made. These settings are made when the ignition is switched off. These settings are;

1- Door distance adjustment :

- The door opens manually to the desired distance, the buzzer is uninterrupted and continuously bounces.
- Press and hold the panel button, is entered into the learning mode (the situation where the buzzer is intermittently interrupted) without leaving the panel knob.
- The door learns the encoder direction by first going to the closing direction and then to the opening direction.
- After this process, the door goes back to the closing direction and closes the door completely.
- The locking catch pulls the door, the buzzer shuts the long probe twice, so the door distance is taught.

WORKING AND CONTROL OF AUTOMATIC DOOR SYSTEM

Door operation settings: It is the part where the operation settings of the control unit are made. These settings are made when the ignition is switched off. These settings are;

2- Doorhandle selection:

- Press and hold the panel button to enter the learning mode.
- The panel button is depressed without leaving as long as the buzzer is interrupted.
- After a while the buzzer is shut up
- Once the long end has been activated, the outer door handle becomes activated
- If the shorter probe bites twice, the outer door arm becomes passive.

Security:

1- When the door is opened:

- If there is an obstacle in the opening direction, the door stops with overcurrent.
- During the opening process, it is expected that the door will be closed again with the panel button or the control.

2- In case of emergency:

- If the vehicle speed is below 20km and the central locks are closed then the vehicle speed falls below 5km, if the ignition is open, the door lock is opened if the outer door is pulled the door can be opened manually with the internal emergency arm on the valve. In this case, the buzzer is constantly bouncing.

WORKING AND CONTROL OF AUTOMATIC DOOR SYSTEM

3- When the door is closed: If one of the following events occurs, the door stops and reopens.

- If a jamming door in the closing direction detects excessive current,
- If there is a impact in the safety wick while the door is closed
- If the door is pulled out while the door is closed
- If the panel button is pressed while the door is closed
- If the control is pressed while the door is closed

On-off commands:

1- Close commands:

- If the vehicle is moving and the vehicle speed is 5 km or more and the door is attempted to be opened from the inside, it closes immediately without allowing manual opening.
- If the door is opened automatically, if the vehicle is started and the handbrake is lowered, the door goes to the close and even if the open commands are given in this position, the door is not opened, it is notified in short tones by voice warning.
 - The door is open and the car speed is 5 km and automatically switches off regardless of how it is opened or in which position it is.
- When the door is open and the vehicle speed is less than 5 km, the parking brake is activated when the handbrake is applied or the ignition is off. The door automatically closes when the control is active.

2- Open commands

When the door is closed and the vehicle speed is below 5 km, the handbrake is applied or the ignition is switched off automatically when the panel switch and the control are active.

ATTENDANCE OF DOOR SYSTEM

- Veldo Automatic Automatic door and step systems must be maintained once a year.
- System General Checks are done.
- The system belt changes.
- The unlocking pattern changes.

NOTE: Uncared products will be evaluated outside the scope of the Guarantee.

TERMS OF GUARANTEE OF DOOR SYSTEM

The terms of the warranty are part of the purchase agreement between the Veldo authorized dealer and the customer. The customer accepts the warranty terms by signature. Veldo guarantee certificate is given to the customer during delivery of the vehicle. The customer is required to present this document in order to be able to process the warranty. All of the automatic door / step including the parts are guaranteed for 2 years. The start of the guarantee is the delivery date of the Product Assembly or Customer.

DISCLAIMER OF WARRANTY TERMS

- Maintenance and repair of the automatic door / step must be carried out on time, regularly, by the appropriate technical knowledge and competent services and in accordance with the periodic maintenance and repair procedures.
- Failure to follow the instructions in the user manual.
- Automatic door / step; is used under improper conditions or under overload except for the purpose,
- If an original or non-equivalent part is attached to the automatic door / step, or if a change has been made by the manufacturer which is not technically approved,
- If the need for repairs in the purchased item is not reported in time,
- In spite of the warning made by the service, if the vehicle owner or the user has not provided the opportunity to repair it
- Defects caused by use in extremely dusty, damp, extreme hot or cold environments
- Failures caused by natural disasters such as flood, fire, earthquake etc.
- The depreciation and abrasion of the parts which are the result of normal use and the nature of the material is not guaranteed. Examples of these pieces that have been subjected to abrasion include system belt, unlocking tines and rollers. However, parts are guaranteed if the material, workmanship and assembly error, that is, the fabrication error, are detected in these parts. If there are any changes or modifications to the product, the warranty does not apply in case of malfunctions.

FAULT DIAGNOSIS AT DOOR SYSTEM

Fault	Cause	Control Points
The door never moves.	<ul style="list-style-type: none"> • The fuse might have been thrown out. • The system belt may be broken. • The unlocking motor may be faulty. • Unlocking cable may be broken. 	<ul style="list-style-type: none"> • Fuse defects should be detected and corrected • The system belt is checked, if it is broken, it is changed. • If the unlocking turns idle and the sound of buzzing sounds, the wire is broken and replaced with the new one. • If the door is operated from the control, the button is defective and the change is made.
The door is opened, the engine is running but the door is not opened.	<ul style="list-style-type: none"> • Unlocking cable may be broken. 	<ul style="list-style-type: none"> • If the unlocking motor is idling and sounding buzzing, the wire is broken and replaced with the new one.
After the door is opened, it is jerking off.	<ul style="list-style-type: none"> • The belt turnbuckle group may be defective. 	<ul style="list-style-type: none"> • The belt turnbuckling spring may be broken, a spring change is made.
The door is moving intermittently when opening / closing.	<ul style="list-style-type: none"> • The reedrelay may be faulty. • The encoder may be faulty. 	<ul style="list-style-type: none"> • A magnet is held in front of the reed relay, and if the lock pulling motor is not working, the reed roll is faulty. • The magnet is held in front of the reed relay, the encoder is defective if the lock pull motor is running.
After the sliding door is commanded, it is going to open continuously.	<ul style="list-style-type: none"> • The reedrelay may be faulty. 	<ul style="list-style-type: none"> • A magnet is held in front of the reed relay, and if the run does not run, the reed relay is faulty.
When the door closes, the buzzing sound comes.	<ul style="list-style-type: none"> • lock puller may be faulty. 	<ul style="list-style-type: none"> • After the door closes, the lock catch is checked. Since there may be a problem in the gear, the lock pulling mechanism is changed.
After the door closes, it stays outside, behind the door remains a gap.	<ul style="list-style-type: none"> • lock puller may be faulty. 	<ul style="list-style-type: none"> • If the magnet is held in front of the reed relay, there is no movement with the lock puller, or if the U is broken.
Security wired does not work	<ul style="list-style-type: none"> • Door control unit may be faulty. If the checks we've done are not working on the final wicket, If the door is not stalled when you trigger the white wire (-) in the main system installation, the control unit is faulty. • There may be a problem with the safety wired electrical installation. 	<ul style="list-style-type: none"> • Open the door. when the brown cable is connected with the white cable, if the door stops and goes back, the wick is defective. Change roving. • If the door stops and does not go back, when I give the white cable (-) trigger to the under the door (OPKON cable) under the front right seat, if the door stops and goes back, there is a break in the OPKON cable under the door. Change the opkon cable. • If the fuse still does not work, the control unit is faulty if the door does not stop and return when you trigger the white wire (-) in the main system installation.